

Varenummer: 201220472

Beskrivelse: E+G Magnet m/gevindbøsning GN 50.2-HF-63-M8  
Hård ferrit - 200° C, 350N

## Mål

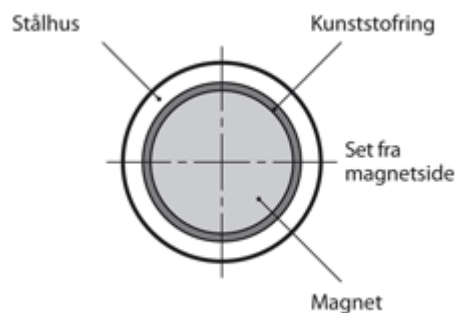

d1 = 63 +0,3/-0,1

d2 = M8x16

d3 = 15 ±0,1

h = 14 +0,5/-0,1

Holdekraft N = 350

Materiale = HF Hård ferrit - 200° C

t = 14